

Introduction - Grade 6 Mathematics

The following released test questions are taken from the Grade 6 Mathematics Standards Test. This test is one of the California Standards Tests administered as part of the Standardized Testing and Reporting (STAR) Program under policies set by the State Board of Education.

All questions on the California Standards Tests are evaluated by committees of content experts, including teachers and administrators, to ensure their appropriateness for measuring the California academic content standards in Grade 6 Mathematics. In addition to content, all items are reviewed and approved to ensure their adherence to the principles of fairness and to ensure no bias exists with respect to characteristics such as gender, ethnicity, and language.

This document contains released test questions from the California Standards Test forms in 2003, 2004, 2005, 2006, 2007, and 2008. First on the pages that follow are lists of the standards assessed on the Grade 6 Mathematics Test. Next are released test questions. Following the questions is a table that gives the correct answer for each question, the content standard that each question is measuring, and the year each question last appeared on the test.

The following table lists each strand/reporting cluster, the number of items that appear on the exam, and the number of released test questions that appear in this document.

STRAND/REPORTING CLUSTER	NUMBER OF QUESTIONS ON EXAM	NUMBER OF RELEASED TEST QUESTIONS
Number Sense – Ratios, Proportions, Percentages, and Negative Fractions	15	21
Number Sense – Operations and Problem Solving with Fractions	10	15
Algebra and Functions	19	30
Measurement and Geometry	10	15
Statistics, Data Analysis, and Probability	11	15
TOTAL	65	96

In selecting test questions for release, three criteria are used: (1) the questions adequately cover a selection of the academic content standards assessed on the Grade 6 Mathematics Test; (2) the questions demonstrate a range of difficulty; and (3) the questions present a variety of ways standards can be assessed. These released test questions do not reflect all of the ways the standards may be assessed. Released test questions will not appear on future tests.

For more information about the California Standards Tests, visit the California Department of Education's Web site at <http://www.cde.ca.gov/ta/tg/sr/resources.asp>.

THE NUMBER SENSE STRAND

In Grade 6, there are two reporting clusters within the Number Sense strand: 1) Ratios, Proportions, Percentages, and Negative Fractions and 2) Operations and Problem Solving with Fractions. This booklet contains released test questions for each of these clusters.

The following four California content standards are included in the Ratios, Proportions, Percentages, and Negative Fractions reporting cluster of the Number Sense strand and are represented in this booklet by 21 test questions. These questions represent only some ways in which these standards may be assessed on the Grade 6 California Mathematics Standards Test.

CALIFORNIA CONTENT STANDARDS IN THIS REPORTING CLUSTER

Number Sense

Standard Set 1.0* Students compare and order positive and negative fractions, decimals, and mixed numbers. Students solve problems involving fractions, ratios, proportions, and percentages:

6NS1.1* Compare and order positive and negative fractions, decimals, and mixed numbers and place them on a number line.

6NS1.2* Interpret and use ratios in different contexts (e.g., batting averages, miles per hour) to show the relative sizes of two quantities, using appropriate notations (a/b , a to b , $a:b$).

6NS1.3* Use proportions to solve problems (e.g., determine the value of N if $4/7 = N/21$, find the length of a side of a polygon similar to a known polygon). Use cross-multiplication as a method for solving such problems, understanding it as the multiplication of both sides of an equation by a multiplicative inverse.

6NS1.4* Calculate given percentages of quantities and solve problems involving discounts at sales, interest earned, and tips.

* Denotes key standards (*Mathematics Framework for California Public Schools*)

The following four California content standards are included in the Operations and Problem Solving with Fractions reporting cluster of the Number Sense strand and are represented in this booklet by 15 test questions. These questions represent only some ways in which these standards may be assessed on the Grade 6 California Mathematics Standards Test.

CALIFORNIA CONTENT STANDARDS IN THIS REPORTING CLUSTER

Number Sense

Standard Set 2.0* Students calculate and solve problems involving addition, subtraction, multiplication, and division:

6NS2.1	Solve problems involving addition, subtraction, multiplication, and division of positive fractions and explain why a particular operation was used for a given situation.
6NS2.2	Explain the meaning of multiplication and division of positive fractions and perform the calculations (e.g., $5/8$ divided by $15/16 = 5/8 \times 16/15 = 2/3$).
6NS2.3*	Solve addition, subtraction, multiplication, and division problems, including those arising in concrete situations, that use positive and negative integers and combinations of these operations.
6NS2.4*	Determine the least common multiple and the greatest common divisor of whole numbers; use them to solve problems with fractions (e.g., to find a common denominator to add two fractions or to find the reduced form for a fraction).

* Denotes key standards (*Mathematics Framework for California Public Schools*)

THE ALGEBRA AND FUNCTIONS STRAND/REPORTING CLUSTER

The following nine California content standards are included in the Algebra and Functions strand/reporting cluster and are represented in this booklet by 30 test questions. These questions represent only some ways in which these standards may be assessed on the Grade 6 California Mathematics Standards Test.

CALIFORNIA CONTENT STANDARDS IN THIS STRAND/CLUSTER

Algebra and Functions	
Standard Set 1.0	Students write verbal expressions and sentences as algebraic expressions and equations; they evaluate algebraic expressions, solve simple linear equations, and graph and interpret their results:
6AF1.1*	Write and solve one-step linear equations in one variable.
6AF1.2	Write and evaluate an algebraic expression for a given situation, using up to three variables.
6AF1.3	Apply algebraic order of operations and the commutative, associative, and distributive properties to evaluate expressions; and justify each step in the process.
6AF1.4	Solve problems manually by using the correct order of operations or by using a scientific calculator.
Standard Set 2.0	Students analyze and use tables, graphs, and rules to solve problems involving rates and proportions:
6AF2.1	Convert one unit of measurement to another (e.g., from feet to miles, from centimeters to inches).
6AF2.2*	Demonstrate an understanding that <i>rate</i> is a measure of one quantity per unit value of another quantity.
6AF2.3	Solve problems involving rates, average speed, distance, and time.
Standard Set 3.0	Students investigate geometric patterns and describe them algebraically:
6AF3.1	Use variables in expressions describing geometric quantities (e.g., $P=2w + 2l$, $A = \frac{1}{2}bh$, $C = \pi d$ — the formulas for the perimeter of a rectangle, the area of a triangle, and the circumference of a circle, respectively).
6AF3.2	Express in symbolic form simple relationships arising from geometry.

* Denotes key standards (*Mathematics Framework for California Public Schools*)

THE MEASUREMENT AND GEOMETRY STRAND/REPORTING CLUSTER

The following six California content standards are included in the Measurement and Geometry strand/reporting cluster and are represented in this booklet by 15 test questions. These questions represent only some ways in which these standards may be assessed on the Grade 6 California Mathematics Standards Test.

CALIFORNIA CONTENT STANDARDS IN THIS STRAND/CLUSTER

Measurement and Geometry

Standard Set 1.0 Students deepen their understanding of the measurement of plane and solid shapes and use this understanding to solve problems:

6MG1.1* Understand the concept of a constant such as π ; know the formulas for the circumference and area of a circle.

6MG1.2 Know common estimates of π (3.14; $22/7$) and use these values to estimate and calculate the circumference and the area of circles; compare with actual measurements.

6MG1.3 Know and use the formulas for the volume of triangular prisms and cylinders (area of base \times height); compare these formulas and explain the similarity between them and the formula for the volume of a rectangular solid.

Standard Set 2.0 Students identify and describe the properties of two-dimensional figures:

6MG2.1 Identify angles as vertical, adjacent, complementary, or supplementary and provide descriptions of these terms.

6MG2.2* Use the properties of complementary and supplementary angles and the sum of the angles of a triangle to solve problems involving an unknown angle.

6MG2.3 Draw quadrilaterals and triangles from given information about them (e.g., a quadrilateral having equal sides but no right angles, a right isosceles triangle).

* Denotes key standards (*Mathematics Framework for California Public Schools*)

THE STATISTICS, DATA ANALYSIS, AND PROBABILITY STRAND/REPORTING CLUSTER

The following nine California content standards are included in the Statistics, Data Analysis, and Probability strand/reporting cluster and are represented in this booklet by 15 test questions. These questions represent only some ways in which these standards may be assessed on the Grade 6 California Mathematics Standards Test.

CALIFORNIA CONTENT STANDARDS IN THIS STRAND/CLUSTER

Statistics, Data Analysis, and Probability

Standard Set 1.0 Students compute and analyze statistical measurements for data sets:

6PS1.1 Compute the range, mean, median, and mode of data sets.

6PS1.2 Understand how additional data added to data sets may affect these computations of measures of central tendency.

6PS1.3 Understand how the inclusion or exclusion of outliers affects measures of central tendency.

Standard Set 2.0 Students use data samples of a population and describe the characteristics and limitations of the samples:

6PS2.2* Identify different ways of selecting a sample (e.g., convenience sampling, responses to a survey, random sampling) and which method makes a sample more representative for a population.

6PS2.5* Identify claims based on statistical data and, in simple cases, evaluate the validity of the claims.

Standard Set 3.0 Students determine theoretical and experimental probabilities and use these to make predictions about events:

6PS3.1* Represent all possible outcomes for compound events in an organized way (e.g., tables, grids, tree diagrams) and express the theoretical probability of each outcome.

6PS3.3* Represent probabilities as ratios, proportions, decimals between 0 and 1, and percentages between 0 and 100 and verify that the probabilities computed are reasonable; know that if P is the probability of an event, $1 - P$ is the probability of an event not occurring.

6PS3.4 Understand that the probability of either of two disjoint events occurring is the sum of the two individual probabilities and that the probability of one event following another, in independent trials, is the product of the two probabilities.

6PS3.5* Understand the difference between independent and dependent events.

* Denotes key standards (*Mathematics Framework for California Public Schools*)

Released Test Questions

Math

6

- 1 Which point shows the location of $\frac{3}{2}$ on the number line?

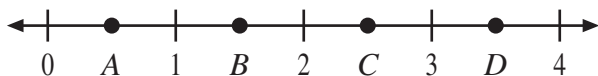

- A point A
B point B
C point C
D point D

CSM02088

- 2 Which list of numbers is ordered from least to greatest?

- A $\frac{1}{2}, 2\frac{1}{2}, 0.2, 0.02$
B $0.02, 0.2, 2\frac{1}{2}, \frac{1}{2}$
C $0.02, 0.2, \frac{1}{2}, 2\frac{1}{2}$
D $0.2, \frac{1}{2}, 0.02, 2\frac{1}{2}$

CSM10986

- 3 Which of the following fractions is closest to 0?

- A $-\frac{5}{12}$
B $-\frac{2}{3}$
C $\frac{5}{6}$
D $\frac{3}{4}$

CSM02279

- 4 What is the order of the following set of numbers from greatest to least?

$$1\frac{1}{3}, \frac{2}{3}, -\frac{1}{3}, \frac{9}{5}$$

- A $-\frac{1}{3}, \frac{2}{3}, \frac{9}{5}, 1\frac{1}{3}$
B $-\frac{1}{3}, 1\frac{1}{3}, \frac{2}{3}, \frac{9}{5}$
C $\frac{9}{5}, \frac{2}{3}, 1\frac{1}{3}, -\frac{1}{3}$
D $\frac{9}{5}, 1\frac{1}{3}, \frac{2}{3}, -\frac{1}{3}$

CSM21467

- 5 Which point best represents $-1\frac{3}{8}$ on the number line below?

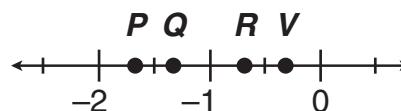

- A P
B Q
C R
D V

CSM40163

- 6 The weekly milk order for the Tranquility Inn includes 40 gallons of low-fat milk and 15 gallons of chocolate milk. What is the ratio of the number of low-fat gallons to chocolate gallons in the Tranquility Inn's weekly milk order?

A 3:1
 B 5:1
 C 5:3
 D 8:3

CSM10813

- 7 $\triangle ABC$ is similar to $\triangle DEF$. What is the length of \overline{DF} ?

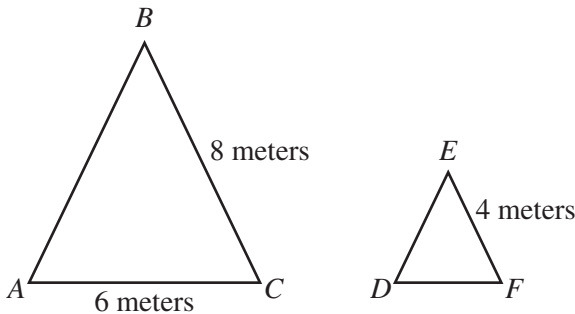

A 2 meters
 B 3 meters
 C 5 meters
 D 10 meters

CSM02300

- 8 A farmer harvested 14,000 pounds of almonds from an 8-acre orchard. Which proportion could be solved to find x , the expected harvest from a 30-acre orchard?

A $\frac{8}{14,000} = \frac{x}{30}$

B $\frac{8}{14,000} = \frac{30}{x}$

C $\frac{30}{14,000} = \frac{x}{8}$

D $\frac{30}{14,000} = \frac{8}{x}$

CSM00274

- 9 A certain map uses a scale of 1 inch equals 25 miles. How many miles are represented by 5 inches on this map?

A 5
 B 25
 C 50
 D 125

CSM10988

Released Test Questions

Math

6

- 10** When wheel *B* turns 2 revolutions, wheel *A* turns 5 revolutions. When wheel *A* turns 40 revolutions, how many revolutions does wheel *B* turn?

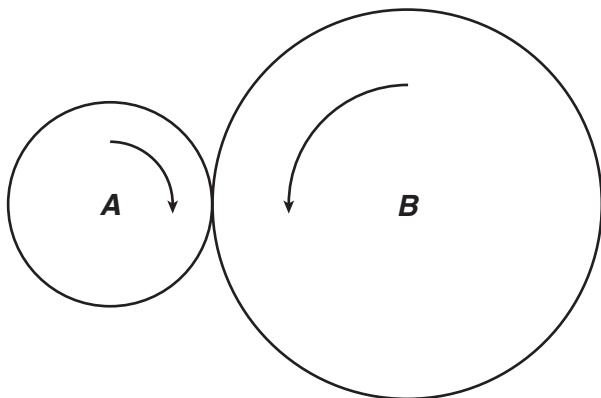

- A 4
B 16
C 80
D 100

CSM21685

- 11** A company makes 5 blue cars for every 3 white cars it makes. If the company makes 15 white cars in one day, how many blue cars will it make?

- A 9
B 13
C 17
D 25

CSM10532

- 12** In a scale drawing, $\frac{1}{2}$ inch represents 3 feet. If the same scale is used, how many inches will be needed to represent 24 feet?

- A 2 inches
B 4 inches
C 8 inches
D 12 inches

CSM02304

- 13** A survey of 1000 registered voters revealed that 450 people would vote for candidate A in an upcoming election. If 220,000 people vote in the election, how many votes would the survey takers predict candidate A should receive?

- A 44,500
B 48,900
C 95,000
D 99,000

CSM20677

- 14 If $\triangle XYZ$ is similar to $\triangle STU$, what is the length of \overline{XY} in centimeters?

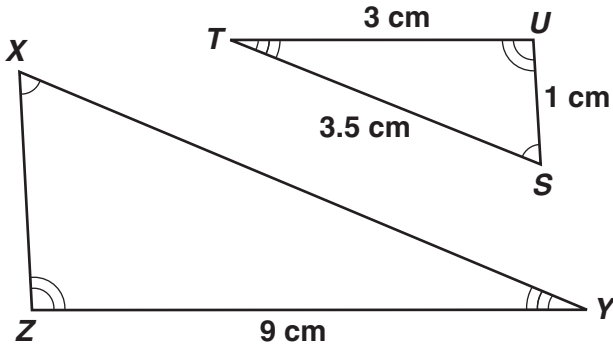

- A 9
B 10.5
C 12
D 12.5

CSM21684

- 15 A model of a park was built on a scale of 1.5 centimeters to 50 meters. If the distance between two trees in the park is 150 meters, what is this distance on the model?

- A 0.5 centimeter
B 4.5 centimeters
C 75 centimeters
D 225 centimeters

CSM20672

- 16 Miranda enlarged a picture proportionally. Her original picture is 4 cm wide and 6 cm long. If the new, larger picture is 10 cm wide, what is its length?

- A 8 cm
B 12 cm
C 15 cm
D 20 cm

CSM20676

- 17 The practice range at a golf course charges \$4.00 for a bucket of 40 golf balls. At this rate, how much will a bucket of 100 golf balls cost?

- A \$10.00
B \$10.50
C \$13.50
D \$16.00

CSM10992

- 18 The vice president of sales took a client out to lunch. If the lunch was \$44 and she gave a 20% tip, how much money did she spend on lunch?

- A \$8.80
B \$35.20
C \$52.80
D \$53.80

CSM02281

Released Test Questions

Math

6

- 19** If 50% of a number is 20, what is 75% of the number?

A 8
B 15
C 30
D 45

CSM10997

- 20** What is 60% of 30?

A 1.8
B 18
C 180
D 1800

CSM02075

- 21** The original price of a new bicycle is \$138.00. If the bicycle is marked down 15%, what is the new price?

A \$20.70
B \$117.30
C \$123.00
D \$153.00

CSM11365

- 22** What is $\frac{10}{11} \times \frac{11}{12}$?

A $\frac{5}{6}$
B $\frac{21}{23}$
C $1\frac{1}{120}$
D 2

CSM10821

- 23** $\frac{7}{9} \times \frac{2}{9} =$

A $\frac{9}{81}$
B $\frac{14}{81}$
C $\frac{9}{9}$
D $\frac{14}{9}$

CSM20780

24 What is the product of $\frac{2}{5}$ and $\frac{4}{5}$?

A $\frac{1}{5}$

B $\frac{8}{25}$

C $\frac{1}{2}$

D $\frac{6}{5}$

CSM20782

25 A group of hikers climbed from Salt Flats (elevation -55 feet) to Talon Bluff (elevation 620 feet). What is the difference in elevation between Talon Bluff and Salt Flats?

A 565 feet

B 575 feet

C 665 feet

D 675 feet

CSM02089

26 $12 \div -3 =$

A 9

B 4

C $-\frac{1}{4}$

D -4

CSM02078

27 One morning, the temperature was 5° below zero. By noon, the temperature rose 20° Fahrenheit (F) and then dropped 8° F by evening. What was the evening temperature?

A 17° below zero

B 15° below zero

C 12° above zero

D 7° above zero

CSM11001

28 $-4 + (-3) =$

A -7

B -1

C 1

D 7

CSM02079

29 The price of a share of stock for company XYZ at the beginning of the week was $\$24.75$. Over the next five days, the stock gained $\$2.50$ on Monday, lost $\$3.25$ on Tuesday, lost $\$0.75$ on Wednesday, gained $\$1.25$ on Thursday, and gained $\$4.75$ on Friday. What was the price of the share of stock at the end of Friday?

A $\$12.25$

B $\$25.75$

C $\$29.25$

D $\$37.25$

CSM11170

Released Test Questions

Math

6

- 30** The ticket prices to a play are \$5.00 for teachers and \$3.00 for students. How much will it cost for a group of 71 students and 5 teachers to see the play?

A \$228.00
B \$238.00
C \$370.00
D \$380.00

CSM20680

- 31** A soccer team has \$90.00 to buy soccer balls. If one soccer ball costs \$15.60, what is the greatest number of soccer balls the team can buy?

A 4
B 5
C 6
D 7

CSM20678

- 32** There are 190 guests at a wedding. What is the least number of circular tables needed to seat all the guests if each table seats exactly 8 people?

A 22
B 23
C 24
D 25

CSM02274

33 $\frac{3}{8} + \frac{1}{12} =$

A $\frac{1}{5}$
B $\frac{1}{6}$
C $\frac{11}{24}$
D $\frac{11}{48}$

CSM00243

- 34** What is the greatest common divisor of 54, 36, and 24?

A 2
B 3
C 6
D 9

CSM11005

- 35** What is $\frac{12}{60}$ expressed in lowest terms?

A $\frac{1}{8}$
B $\frac{1}{6}$
C $\frac{1}{5}$
D $\frac{1}{4}$

CSM20746

- 36** What greatest common factor should be used to

reduce the fraction $\frac{14}{70}$ to its simplest form?

- A 2
- B 7
- C 10
- D 14

CSM11008

- 37** What value of k makes the following equation true?

$$k \div 3 = 36$$

- A 108
- B 98
- C 39
- D 12

CSM01355

- 38** The Sojourn family went on a vacation. They started with \$2000. If they spent \$150 each day, which expression represents how much money they had after x days?

- A $1850x$
- B $2000 - 150x$
- C $150x$
- D $2000 + 150x$

CSM02288

- 39** Ellen had some change in her pocket. After her friend gave her \$0.45, Ellen had \$1.35 altogether. Which equation can she use to find the original amount of money, m , she had in her pocket?

- A $m + 0.45 = 1.35$
- B $1.35 = m - 0.45$
- C $m = 1.35 \times 0.45$
- D $m + 1.35 = 0.45$

CSM20685

- 40** Which algebraic equation best describes the total growth (T) in height of pine trees over a 3-year period, if g equals the rate of growth in centimeters per year?

- A $T = 3g$
- B $T = 3 + g$
- C $T = \frac{g}{3}$
- D $T = \frac{3}{g}$

CSM21694

Released Test Questions

Math

6

41 If $x - 3 = 6$, what is the value of x ?

- A 2
- B 3
- C 6
- D 9

CSM10968

42 What is x if $3x = 84$?

- A 20
- B 21
- C 26
- D 28

CSM21693

43 In the equation $x + y = 4$, what is the value of x if $y = 2$?

- A 2
- B 4
- C 6
- D 8

CSM30458

44 Courtney has to answer this question correctly for her team to win the math review game.

If a cornstalk grows 8 inches every month, how many months (m) will it take for the cornstalk to be 70 inches tall?

Which equation can be used to solve this problem?

- A $m + 8 = 70$
- B $m - 8 = 70$
- C $8m = 70$
- D $\frac{m}{8} = 70$

CSM11174

45 What value of r makes $\frac{r}{-11} = -3$ true?

- A -33
- B -8
- C 8
- D 33

CSM11175

- 46** A telephone company charges \$0.05 per minute for local calls and \$0.12 per minute for long-distance calls. Which expression gives the total cost in dollars for x minutes of local calls and y minutes of long-distance calls?

- A $0.05x + 0.12y$
 B $0.05x - 0.12y$
 C $0.17(x + y)$
 D $0.17xy$

CSM01299

- 47** Rita is moving a pile of 120 rocks by hand to build a rock wall. If h represents the number of rocks that she can carry in one load, which expression represents the total number of loads needed to move the entire pile of rocks?

- A $120 + h$
 B $120h$
 C $120 - h$
 D $\frac{120}{h}$

CSM30462

- 48** The steps Quentin took to evaluate the expression $3m - 3 \div 3$ when $m = 8$ are shown below.

$$\begin{array}{l} 3m - 3 \div 3 \text{ when } m = 8 \\ 3 \times 8 = 24 \\ 24 - 3 = 21 \\ 21 \div 3 = 7 \end{array}$$

What should Quentin have done differently in order to evaluate the expression?

- A divided $(24 - 3)$ by (24×3)
 B divided $(24 - 3)$ by $(24 - 3)$
 C subtracted $(3 \div 3)$ from 24
 D subtracted 3 from $(24 \div 3)$

CSM10804

- 49** $8 + 8 \div 2 + 2 =$

- A 4
 B 8
 C 10
 D 14

CSM02058

- 50** $(5 + 2)[6 - (3 + 2)] =$

- A 7
 B 8
 C 12
 D 13

CSM20789

Released Test Questions

Math

6

51 How many inches are in $2\frac{1}{2}$ feet?

- A 24 inches
- B 25 inches
- C 29 inches
- D 30 inches

CSM01773

52 Sandra had a recipe that required $\frac{1}{3}$ pound of beef.

Pound Equivalent

1 pound = 453.6 grams

Using the table above, about how many grams of beef does she need?

- A 5
- B 151
- C 454
- D 1361

CSM30080

53 It takes a machine 12 minutes to fill 200 bottles of soda. At this rate, how many minutes will it take the machine to fill 500 bottles of soda?

- A 25 minutes
- B 28 minutes
- C 30 minutes
- D 40 minutes

CSM02066

54 Trish's resting heart rate is 50 beats per minute. For every minute she exercises, her heart rate increases 5 beats per minute. How long will it take her to reach a heart rate of 120 beats per minute?

- A 5 minutes
- B 14 minutes
- C 34 minutes
- D 70 minutes

CSM11181

55 Marcus spent \$3.25 to wash his car. If one quarter operates the car wash for 60 seconds, how long did it take him to wash his car?

- A 10 minutes
- B 13 minutes
- C 16 minutes
- D 32.5 minutes

CSM11180

56 A car gets 24 miles per gallon of gasoline (mi/gal). How many gallons of gasoline would the car need to travel 144 miles?

- A 6.5 gallons
- B 6 gallons
- C 5.5 gallons
- D 5 gallons

CSM02086

57 Sheila has been given 5 minutes to solve 20 arithmetic problems. What is the minimum rate Sheila can work in order to finish in time?

- A 1 problem per minute
- B 2 problems per minute
- C 4 problems per minute
- D 5 problems per minute

CSM20756

58 A water tank will hold 50 gallons. What flow rate, in gallons per second, is required to fill the tank in 20 seconds?

- A 0.4
- B 2.5
- C 16.7
- D 70

CSM21699

59 A snail is trying to get to the other side of a park. At what rate is the snail traveling?

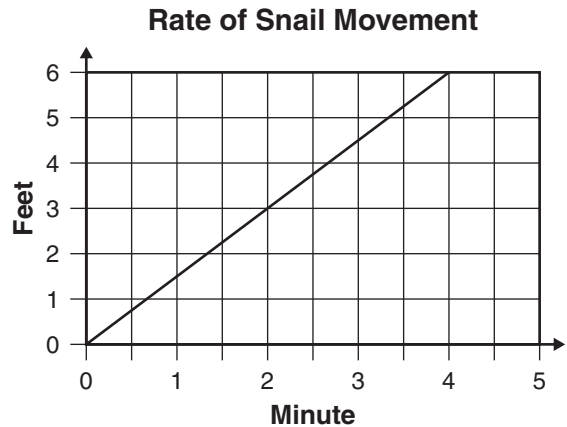

- A $\frac{1}{2}$ foot per minute
- B 1 foot per minute
- C $1\frac{1}{2}$ feet per minute
- D 2 feet per minute

CSM21361

Released Test Questions

Math

6

60 Marshall wants to finish typing his English paper before class starts. If he still has 550 words left to type and class starts in 25 minutes, at least how fast must Marshall type to finish his paper on time?

- A 20 words per minute
- B 21 words per minute
- C 22 words per minute
- D 25 words per minute

CSM21365

61 Mai earns \$5.50 per hour at her after-school job. How many hours does she have to work to earn \$132?

- A 16
- B 20
- C 24
- D 28

CSM10977

62 Jerry read a 200-page book in 10 hours. At that rate, how long will it take him to read a 320-page book?

- A 16 hours
- B 18 hours
- C 24 hours
- D 32 hours

CSM01776

63 If a freight train travels at a speed of 20 miles per hour for 6 hours, how far will it travel?

- A 120 miles
- B 80 miles
- C 26 miles
- D 12 miles

CSM01834

64 A square with a side of x is inside a square with a side of 4, as pictured below. Which expression represents the area of the shaded region in terms of x ?

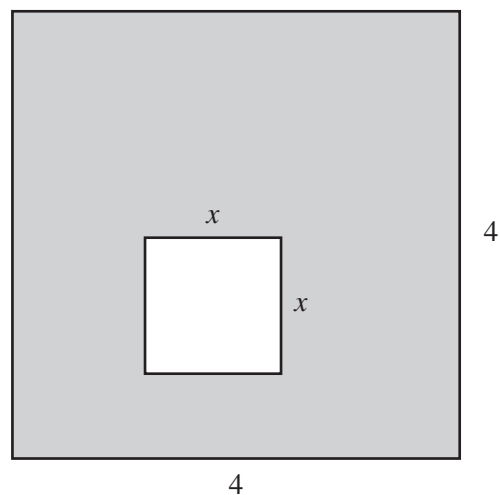

- A $16 + x^2$
- B $16 - x^2$
- C $16 - 2x$
- D $16 - 4x$

CSM02302

- 65 The rectangle shown below has length 15 inches and perimeter P inches.

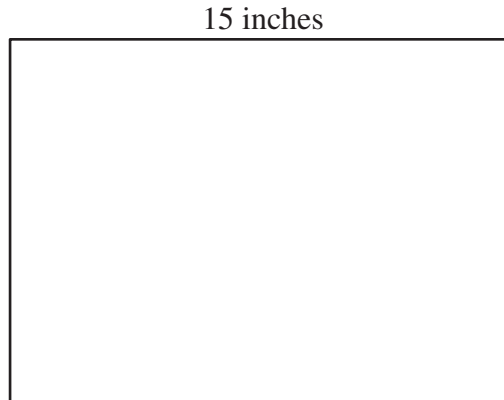

Which equation could be used to find the width of the rectangle?

- A $P = 15 + \frac{w}{2}$
 B $P = 15 - w$
 C $P = 30 + 2w$
 D $P = 30 - 2w$

CSM00286

- 66 An isosceles triangle has two sides with length x .

The third side is $\frac{1}{2}$ of x . What is the perimeter?

- A $2\frac{1}{2}x$
 B $3x$
 C $4\frac{1}{2}x$
 D $5x$

CSM10793

- 67 Which equation could be used to find the area in square inches of a circle with a radius of 8 inches?

- A $A = 4 \times \pi$
 B $A = \pi \times 4^2$
 C $A = 8 \times \pi$
 D $A = \pi \times 8^2$

CSM01329

Released Test Questions

Math

6

- 68** A Ferris wheel at the local fair has a diameter of 52 meters. Which expression can be used to find its circumference, C , in meters?

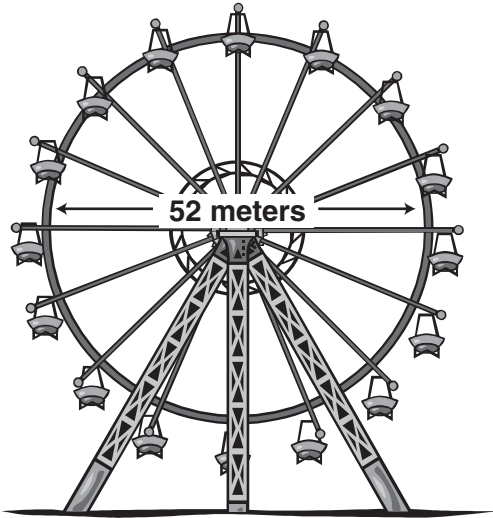

- A $C = 26 \times \pi$
 B $C = 52 \times \pi$
 C $C = 2 \times 52 \times \pi$
 D $C = 26^2 \pi$

CSM10951

- 69** A bicycle wheel has an inside radius of 12 inches. Which expression could be used to find the inside circumference of this wheel?

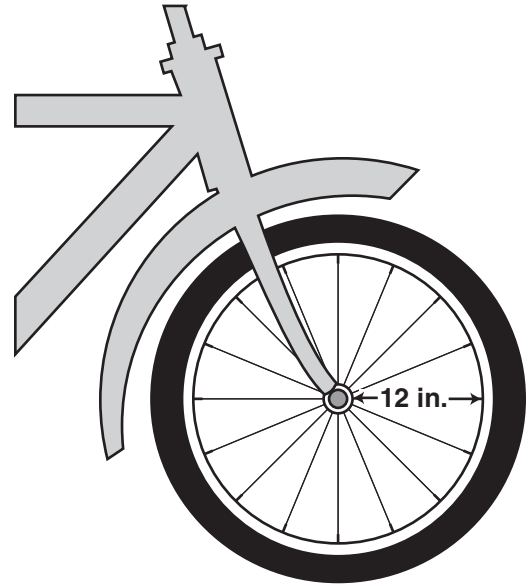

- A $2 \times 6 \times \pi$
 B $2 \times 12 \times \pi$
 C $9 \times 9 \times \pi$
 D $12 \times 12 \times \pi$

CSM10950

- 70 This circular stage has a radius of 25 meters.

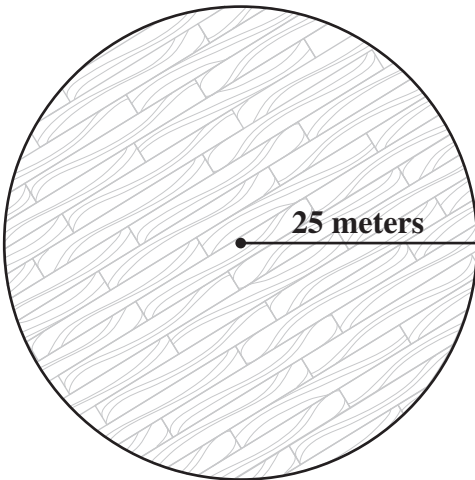

Which equation could be used to find the area of the stage in square meters?

- A $A = 25\pi$
- B $A = 50\pi$
- C $A = \pi \cdot 25^2$
- D $A = \pi \cdot 50^2$

CSM02059

- 71 A circular tree trunk has a diameter of 8 feet. Which equation could be used to find the distance in feet around the tree trunk?

- A $C = 4\pi$
- B $C = 8\pi$
- C $C = 16\pi$
- D $C = 64\pi$

CSM02057

- 72 The top part of this hat is shaped like a cylinder with a diameter of 7 inches.

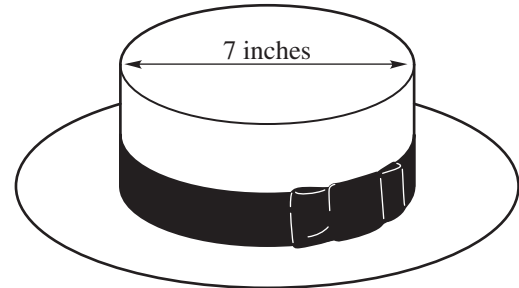

Which measure is *closest* to the length of the band that goes around the outside of the hat?

- A 10.1 inches
- B 11.0 inches
- C 22.0 inches
- D 38.5 inches

CSM00268

- 73 A dime has a radius of about 0.85 cm. Which measurement is closest to the circumference of a dime?

- A 1.33 cm
- B 1.70 cm
- C 2.67 cm
- D 5.34 cm

CSM10981

Released Test Questions

Math

6

74 A tank is in the shape of a triangular prism. If the triangular base has an area of 116 square feet, and the tank is 30 feet tall, how much water would the tank contain when it is full?

- A 1725 ft³
- B 1740 ft³
- C 3480 ft³
- D 6960 ft³

CSM20796

75 Which is a true statement about angles 1 and 2 shown below?

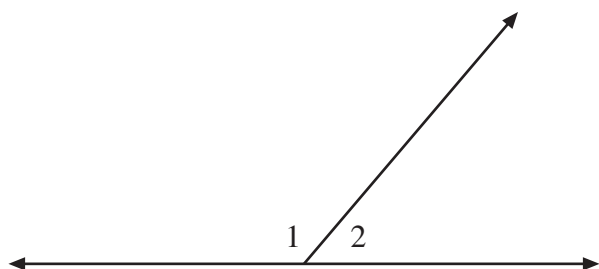

- A $\angle 1$ is complementary to $\angle 2$.
- B $\angle 1$ is supplementary to $\angle 2$.
- C Both angles are obtuse.
- D Both angles are acute.

CSM02081

76 What is the measure of angle 1 in the figure below?

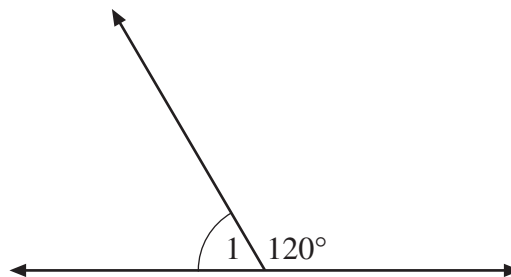

- A 30°
- B 40°
- C 60°
- D 80°

CSM02087

77 In the figure below, \overleftrightarrow{CD} intersects \overleftrightarrow{AB} at F , $m\angle CFB = 50^\circ$, and $\angle EFA \cong \angle AFD$. What is $m\angle EFC$?

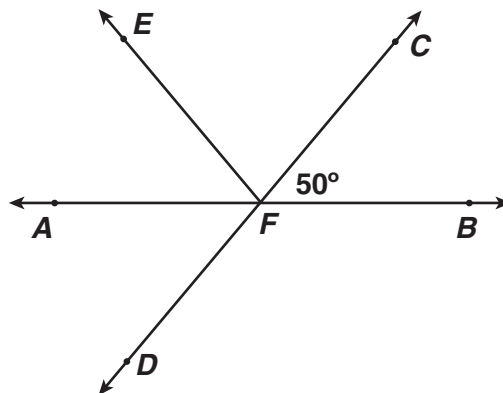

- A 40°
- B 50°
- C 70°
- D 80°

CSM10962

- 78** In the figure below, $\triangle ABC$ is a right triangle and $m\angle A = 40^\circ$.

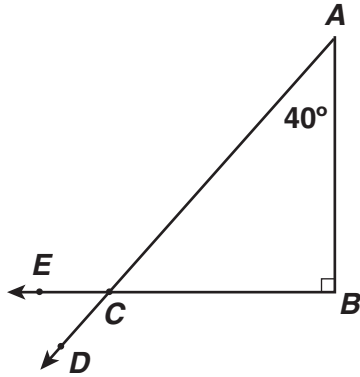

What is $m\angle ECD$?

- A 40°
- B 50°
- C 130°
- D 140°

CSM10960

- 79** What is the supplement of a 40° angle?

- A 50°
- B 130°
- C 140°
- D 220°

CSM20689

- 80** In this triangle, what is the measure of $\angle C$?

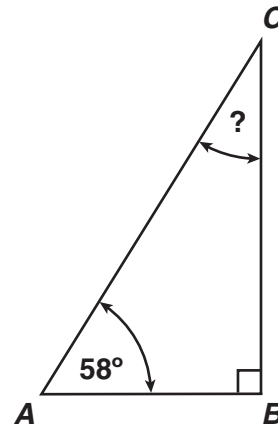

- A 32°
- B 42°
- C 58°
- D 122°

CSM00509

Released Test Questions

Math

6

- 81 Which figure is an acute triangle?

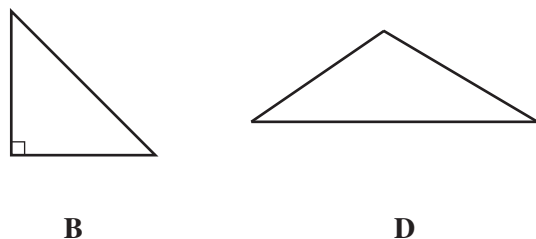
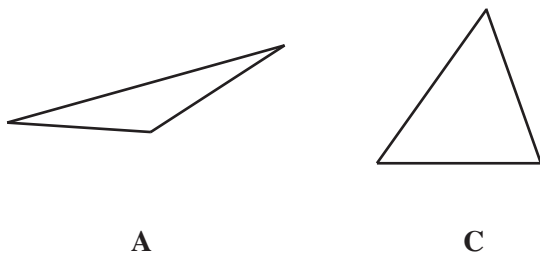

CSM10357

- 82 Jeremiah is on the Eagles bowling team. His scores for the last 12 games are shown below.

90, 103, 110, 95, 105, 110, 90, 112, 110, 96, 94, 110
--

What is the mode of the scores?

- A 90
B 102
C 104
D 110

CSM10787

- 83 Abe found the mean and median of this list of numbers.

1, 3, 3

If the number 6 were added to the list, then

- A the mean would increase.
B the mean would decrease.
C the median would increase.
D the median would decrease.

CSN00268

- 84 A snack bar sells 5 items with a mean (average) price of \$0.60, as shown below.

Snack Menu	
Chips	\$0.50
Juice	\$0.80
Apple	\$0.60
Candy	\$0.70
Gum	\$0.40

Which pair of items could be added to the menu without changing the average price?

- A Banana (\$0.60) and Soda (\$0.75)
B Banana (\$0.60) and Cookie (\$0.50)
C Energy Bar (\$0.45) and Cookie (\$0.50)
D Energy Bar (\$0.45) and Soda (\$0.75)

CSN00031

85 Marguerite earned a score between 75 and 89 on all of her previous spelling tests. She earned a score of 100 on her next test. Which of the following statements is true?

- A The mode will increase.
- B The mean will increase.
- C The mean will decrease.
- D The median will decrease.

CSM3019

86 Wendy wants to take a survey to determine which flavor of ice cream is the most popular at her school. Which of the following methods is the *best* way for her to choose a random sample of the students at her school?

- A selecting ten students from each homeroom
- B selecting members of the girls' softball team
- C selecting members of the boys' basketball team
- D selecting students who like her favorite flavor of ice cream

CSM20726

87 Celia has a large container in which four different kinds of coins are thoroughly mixed. She wants to take a sample of her coins to estimate which kind of coin she has the most. Which of the following methods is the *best* way for her to select a sample?

- A taking one coin from the container
- B taking coins until she has one of every kind
- C taking ten coins of each type from the container
- D taking thirty coins out of the container without looking

CSM20725

88 Emil wants to find out the most popular football team at a game between the home team and the visiting team. Which of the following methods will give him the *most* accurate results?

- A surveying the cheerleaders for the home team
- B surveying people wearing hats for the visiting team
- C surveying a group of people standing in line for tickets
- D surveying people who do not live in the home team's city

CSM20727

89 A shopping mall wants to conduct a survey of the people who shop at the mall. Which would give them the most representative sample?

- A conducting the survey at one shoe store
- B conducting the survey at all shoe stores
- C conducting the survey at the entrance to the mall
- D conducting the survey a mile away from the mall

CSN00273

Released Test Questions

Math

6

- 90** The table shows the annual profit for five companies.

2003 Profits

Company	Profit
I	\$300,000
II	\$275,000
III	\$250,000
IV	\$325,000
V	\$300,000

Which statement is valid about the annual profits of these five companies?

- A Companies II and V made the same profit.
- B No company made less than \$275,000 profit.
- C No company made more than \$300,000 profit.
- D Company IV made \$75,000 more profit than Company III.

CSM20772

- 91** Ms. Hatley is going to choose one person from each of the two lists below to represent the class in student council.

List 1	List 2
Ann	Dave
Carlos	Mia
Lisa	

Which set shows *all* the possible choices of two people?

- A {(Ann, Carlos), (Ann, Lisa)}
- B {(Ann, Dave), (Ann, Mia)}
- C {(Ann, Dave), (Carlos, Mia), (Lisa, Dave), (Lisa, Mia)}
- D {(Ann, Dave), (Ann, Mia), (Carlos, Dave), (Carlos, Mia), (Lisa, Dave), (Lisa, Mia)}

CSN00310

- 92** A store is selling USA Spirit T-shirts. The shirts are available in red, blue, and white. Shirts of each color are available in sizes small, medium, large, and extra large.

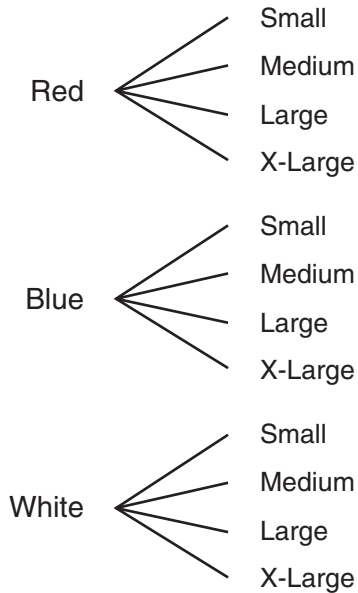

Aimee will randomly select one shirt from a shelf. If the shelf contains equal numbers of shirts in each color and size combination, what is the probability that Aimee will select a large shirt?

- A $\frac{1}{12}$
- B $\frac{1}{4}$
- C $\frac{1}{3}$
- D $\frac{11}{12}$

CSM10526

- 93** The table shows how many T-shirts of each color Paul has in his closet.

Color	Number of Shirts
Green	3
Red	4
White	5
Blue	8
Total	20

If Paul chooses a T-shirt without looking, what is the probability that it will be blue?

- A 4%
- B 8%
- C 40%
- D 60%

CSN00191

- 94** Mason has 10 black, 12 white, and 3 brown pairs of socks in one drawer. What is the probability that, without looking, Mason will pick a brown pair of socks from the drawer?

- A 4%
- B 12%
- C 14%
- D $33\frac{1}{3}\%$

CSM11016

Released Test Questions

Math

6

95 A drawer is filled with red and blue socks. If the probability of selecting a red sock at random is $\frac{2}{5}$, what is the probability that a blue sock will be chosen at random?

- A $\frac{2}{5}$
- B $\frac{3}{5}$
- C $\frac{2}{3}$
- D $\frac{3}{2}$

CSM20758

96 In her pocket, Kira has 2 red marbles, 2 green marbles, and 2 blue marbles that are all the same size. If Kira picks one marble out of her pocket without looking, what is the probability that it will be either red or green?

- A $\frac{1}{6}$
- B $\frac{1}{3}$
- C $\frac{1}{2}$
- D $\frac{2}{3}$

CSN00272

Question Number	Correct Answer	Standard	Year of Release
1	<i>B</i>	6NS1.1	2003
2	<i>C</i>	6NS1.1	2004
3	<i>A</i>	6NS1.1	2005
4	<i>D</i>	6NS1.1	2007
5	<i>B</i>	6NS1.1	2008
6	<i>D</i>	6NS1.2	2004
7	<i>B</i>	6NS1.3	2003
8	<i>B</i>	6NS1.3	2004
9	<i>D</i>	6NS1.3	2005
10	<i>B</i>	6NS1.3	2005
11	<i>D</i>	6NS1.3	2006
12	<i>B</i>	6NS1.3	2006
13	<i>D</i>	6NS1.3	2007
14	<i>B</i>	6NS1.3	2007
15	<i>B</i>	6NS1.3	2008
16	<i>C</i>	6NS1.3	2008
17	<i>A</i>	6NS1.3	2008
18	<i>C</i>	6NS1.4	2003
19	<i>C</i>	6NS1.4	2004
20	<i>B</i>	6NS1.4	2006
21	<i>B</i>	6NS1.4	2006
22	<i>A</i>	6NS2.1	2004
23	<i>B</i>	6NS2.1	2007
24	<i>B</i>	6NS2.2	2005
25	<i>D</i>	6NS2.3	2003
26	<i>D</i>	6NS2.3	2003
27	<i>D</i>	6NS2.3	2004
28	<i>A</i>	6NS2.3	2005
29	<i>C</i>	6NS2.3	2006
30	<i>B</i>	6NS2.3	2006
31	<i>B</i>	6NS2.3	2007
32	<i>C</i>	6NS2.3	2008
33	<i>C</i>	6NS2.4	2003
34	<i>C</i>	6NS2.4	2005
35	<i>C</i>	6NS2.4	2006

Question Number	Correct Answer	Standard	Year of Release
36	<i>D</i>	6NS2.4	2008
37	<i>A</i>	6AF1.1	2003
38	<i>B</i>	6AF1.1	2004
39	<i>A</i>	6AF1.1	2005
40	<i>A</i>	6AF1.1	2005
41	<i>D</i>	6AF1.1	2006
42	<i>D</i>	6AF1.1	2006
43	<i>A</i>	6AF1.1	2007
44	<i>C</i>	6AF1.1	2008
45	<i>D</i>	6AF1.1	2008
46	<i>A</i>	6AF1.2	2003
47	<i>D</i>	6AF1.2	2008
48	<i>C</i>	6AF1.3	2004
49	<i>D</i>	6AF1.4	2005
50	<i>A</i>	6AF1.4	2007
51	<i>D</i>	6AF2.1	2003
52	<i>B</i>	6AF2.1	2007
53	<i>C</i>	6AF2.2	2003
54	<i>B</i>	6AF2.2	2004
55	<i>B</i>	6AF2.2	2005
56	<i>B</i>	6AF2.2	2005
57	<i>C</i>	6AF2.2	2006
58	<i>B</i>	6AF2.2	2006
59	<i>C</i>	6AF2.2	2007
60	<i>C</i>	6AF2.2	2008
61	<i>C</i>	6AF2.2	2008
62	<i>A</i>	6AF2.3	2004
63	<i>A</i>	6AF2.3	2007
64	<i>B</i>	6AF3.1	2004
65	<i>C</i>	6AF3.2	2003
66	<i>A</i>	6AF3.2	2007
67	<i>D</i>	6MG1.1	2003
68	<i>B</i>	6MG1.1	2004
69	<i>B</i>	6MG1.1	2005
70	<i>C</i>	6MG1.1	2007

Question Number	Correct Answer	Standard	Year of Release
71	<i>B</i>	6MG1.1	2008
72	<i>C</i>	6MG1.2	2003
73	<i>D</i>	6MG1.2	2007
74	<i>C</i>	6MG1.3	2006
75	<i>B</i>	6MG2.1	2004
76	<i>C</i>	6MG2.2	2003
77	<i>D</i>	6MG2.2	2005
78	<i>B</i>	6MG2.2	2006
79	<i>C</i>	6MG2.2	2007
80	<i>A</i>	6MG2.2	2008
81	<i>C</i>	6MG2.3	2004
82	<i>D</i>	6PS1.1	2008
83	<i>A</i>	6PS1.2	2004
84	<i>D</i>	6PS1.2	2007
85	<i>B</i>	6PS1.3	2007
86	<i>A</i>	6PS2.2	2005
87	<i>D</i>	6PS2.2	2006
88	<i>C</i>	6PS2.2	2006
89	<i>C</i>	6PS2.2	2008
90	<i>D</i>	6PS2.5	2005
91	<i>D</i>	6PS3.1	2003
92	<i>B</i>	6PS3.1	2006
93	<i>C</i>	6PS3.3	2003
94	<i>B</i>	6PS3.3	2004
95	<i>B</i>	6PS3.3	2008
96	<i>D</i>	6PS3.4	2005